

REPUBLIC OF KENYA

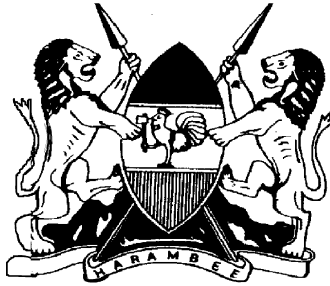

COUNTY GOVERNMENT OF NAKURU

**PROPOSED ROUTINE MAINTENANCE AND SPOT IMPROVEMENT OF
KTDA - RIPRIP ROAD IN KIPTAGICH WARD - KURESOI SOUTH SUB
COUNTY**

CGN/ RTPW/109/R/2017/2018

Instruction to Tenderers

Agreement

Annexes

CLOSING DATE: 12th FEBRUARY 2019 at 12.00AM

PREPARED BY:

Department of Roads, Transport & Public Works
Directorate of Roads & Transport
P.O. Box 2870 – 20100

NAKURU

ISSUED BY:

Department of Roads, Transport & Public Works
Directorate of Roads & Transport
P.O. Box 2870 – 20100

NAKURU

TABLE OF CONTENTS

		PAGE
SECTION I	INVITATION TO TENDER.....	3
SECTION II	INSTRUCTIONS TO TENDERERS.....	4
	Appendix to Instructions to Tenderers	16
SECTION III	GENERAL CONDITIONS OF CONTRACT.....	20
SECTION IV	SPECIAL CONDITIONS OF CONTRACT.....	25
SECTION V	SCHEDULE OF REQUIREMENTS.....	26
SECTION VI	TECHNICAL SPECIFICATIONS.....	27
SECTION VII	PRICE SCHEDULE FOR GOODS.....	37
SECTION VIII	STANDARD FORMS.....	38
8.1	FORM OF TENDER.....	39
8.2	CONFIDENTIAL BUSINESS QUESTIONNAIRES FORMS.....	40
8.3	TENDER SECURITY FORM.....	41
8.4	CONTRACT FORM.....	42
8.5	PERFORMANCE SECURITY FORM.....	43
8.6	BANK GUARANTTE FOR ADVANCE PAYMENT FORM.....	44
8.7	MANUFACTURER’S AUTHORIZATION FORM.....	45

SECTION II - INSTRUCTIONS TO TENDERERS

Table of Clauses

	Page
2.1 Eligible tenderers.....	4
2.2 Eligible goods.....	4
2.3 Cost of tendering.....	4
2.4 Contents of Tender document.....	5
2.5 Clarification of documents.....	5
2.6 Amendment of documents.....	5
2.7 Language of tender.....	6
2.8 Documents comprising the tender.....	6
2.9 Tender forms.....	6
2.10 Tender prices.....	6
2.11 Tender currencies.....	6
2.12 Tenderers eligibility and qualifications.....	7
2.13 Goods' eligibility and conformity to tender documents.....	7
2.14 Tender security.....	8
2.15 Validity of tenders.....	9
2.16 Format and signing of tenders.....	9
2.17 Sealing and marking of tenders.....	9
2.18 Deadline for submission of tender	10
2.19 Modification and withdrawal of tenders.....	10
2.20 Opening of tenders.....	11
2.21 Clarification of tenders.....	11
2.22 Preliminary examination.....	11
2.23 Conversion to single currency.....	12
2.24 Evaluation and comparison of tenders.....	12
2.25 Preference.....	13
2.26 Contacting the procuring entity.....	13
2.27 Award of contract.....	13
(a) Post qualification.....	13
(b) Award criteria.....	13
(c) Procuring entity's right to vary quantities....	14
(d) Procuring entity's right to accept or reject any or all tenders	14
2.28 Notification of award.....	14
2.29 Signing of contract.....	14
2.30 Performance security.....	15
2.31 Corrupt or fraudulent practices.....	15

SECTION I INVITATION TO TENDER
DATE: 28/01/2019

TENDER REF NO. CGN/ RTPW/109/R/2017/2018

**TENDER NAME : PROPOSED ROUTINE MAINTENANCE AND SPOT IMPROVEMENT
OF KTDA - RIPRIP ROAD IN KIPTAGICH WARD - KURESOI SOUTH SUB COUNTY**

- 1.1 The Nakuru County Government invites bids from eligible candidates for **Routine Maintenance and Spot Improvement of KTDA - Riprip Road in Kiptagich Ward - Kuresoi South Sub County**
- 1.2 Interested eligible candidates may obtain further information from and inspect the tender documents at Supply and Chain Managers' office at Nakuru County Headquarters Box 2870 Nakuru during normal working hours.
- 1.3 A complete set of tender documents may be downloaded from the Nakuru County Government's website: www.nakuru.go.ke or IFMIS suppliers' portal; supplier.treasury.go.ke.
- 1.4 Prices quoted should be net inclusive of all taxes and delivery must be in Kenya Shillings and shall remain valid for 150 days from the closing date of the tender.
- 1.5 Completed tender documents are to be submitted through IFMIS so as to reach:

County Secretary
Nakuru County Government
P.O. Box 2870 – 20100
NAKURU

On or before **12th February 2019 at 12.00a.m**

- 1.6 The IFMIS system will automatically lock out at the time and date of tender closing.
- 1.1 Tenders must be accompanied by a bid bond of NONE.... of the quoted sum. The IFMIS system will automatically lock out at the time and date of tender closing

**A MANDATORY PRE-TENDER SITE VISIT FOR ALL ROADS IS SCHEDULED ON
5TH FEBRUARY 2019 AT 9.30AM ALL TO ASSMBLE AT THE VARIUOS SUB
COUNTY HEADQUARTERS**

SECTION II - INSTRUCTIONS TO TENDERERS

2.1 Eligible Tenderers

- 2.1.1 This Invitation for Tenders is open to all tenderers eligible as described in the Appendix to instruction to Tender. Successful tenderers shall complete the supply of goods by the intended completion date specified in the tender document.
- 2.1.2 The procuring entity's employees, committee members, board members and their relative (spouse and children) are not eligible to participate in the tender unless where specially allowed under section 131 of the Act.
- 2.1.3 Tenderers shall provide the qualification information statement that the tenderer (including all members of a joint venture and subcontractors) is not associated, or have been associated in the past, directly or indirectly, with a firm or any of its affiliates which have been engaged by the Procuring entity to provide consulting services for the preparation of the design, specifications, and other documents to be used for the procurement of the goods under this Invitation for tenders.
- 2.1.4 Tenderers involved in corrupt and fraudulent practices or debarred from participating in Public Procurement shall not be eligible.

2.2 Eligible Goods

- 2.2.1 All goods to be supplied under the contract shall have their origin in eligible source countries.
- 2.2.2 For purposes of this clause, "origin" means the place where the goods are mined, grown, or produced. Goods are produced when, through manufacturing, processing, or substantial and major assembly of components, a commercially-recognized product results that is substantially different in basic characteristics or in purpose or utility from its components
- 2.2.3 The origin of goods is distinct from the nationality of the tenderer and shall be treated thus in the evaluation of the tender.

2.3 Cost of Tendering

- 2.3.1 The Tenderer shall bear all costs associated with the preparation and submission of its tender, and the procuring entity, will in no case be responsible or liable for those costs, regardless of the conduct or outcome of the tendering process.
- 2.3.2 The price to be charged for the tender document shall not exceed Kshs.1,000/=
- 2.3.3 The procuring entity shall allow the tenderer to review the tender document free of charge before purchase.

2.4. Contents of Tender Document

- 2.4.1 The tender document comprises the documents listed below and addenda issued in accordance with clause 2.6 of these instructions to Tenderers
- (i) Invitation to Tender
 - (ii) Instructions to tenderers
 - (iii) General Conditions of Contract
 - (iv) Special Conditions of Contract
 - (v) Schedule of requirements
 - (vi) Technical Specifications
 - (vii) Tender Form and Price Schedules
 - (viii) Tender Security Form
 - (ix) Contract Form
 - (x) Performance Security Form
 - (xi) Bank Guarantee for Advance Payment Form
 - (xii) Manufacturer's Authorization Form
 - (xiii) Confidential Business Questionnaire
 - (xiv) Declaration Form
 - (xv) Request for Review Form
- 2.4.2 The Tenderer is expected to examine all instructions, forms, terms, and specifications in the tender documents. Failure to furnish all information required by the tender documents or to submit a tender not substantially responsive to the tender documents in every respect will be at the tenderers risk and may result in the rejection of its tender.

2.5 Clarification of Documents

- 2.5.1 A prospective tenderer requiring any clarification of the tender document may notify the Procuring entity in writing or by post at the entity's address indicated in the Invitation to Tender. The Procuring entity will respond in writing to any request for clarification of the tender documents, which it receives not later than seven (7) days prior to the deadline for the submission of tenders, prescribed by the procuring entity. Written copies of the Procuring entities response (including an explanation of the query but without identifying the source of inquiry) will be sent to all prospective tenderers that have received the tender document.
- 2.5.2 The procuring entity shall reply to any clarifications sought by the tenderer within 3 days of receiving the request to enable the tenderer to make timely submission of its tender.

2.6 Amendment of Documents

- 2.6.1 At any time prior to the deadline for submission of tenders, the Procuring entity, for any reason, whether at its own initiative or in response to a clarification requested by a prospective tenderer, may modify the tender documents by issuing an addendum.
- 2.6.2 All prospective candidates that have received the tender documents will be notified of the amendment in writing or by post and will be binding on them.
- 2.6.3 In order to allow prospective tenderers reasonable time in which to take the amendment into account in preparing their tenders, the Procuring entity, at its discretion, may extend the deadline for the submission of tenders.

2.7 Language of Tender

2.7.1 The tender prepared by the tenderer, as well as all correspondence and documents relating to the tender exchange by the tenderer and the Procuring entity, shall be written in English language, provided that any printed literature furnished by the tenderer may be written in another language provided they are accompanied by an accurate English translation of the relevant passages in which case, for purposes of interpretation of the tender, the English translation shall govern.

2.8 Documents Comprising of Tender

2.8.1 The tender prepared by the tenderers shall comprise the following components

- (a) a Tender Form and a Price Schedule completed in accordance with paragraph 2.9, 2.10 and 2.11 below
- (b) documentary evidence established in accordance with paragraph 2.1.2 that the tenderer is eligible to tender and is qualified to perform the contract if its tender is accepted;
- (c) documentary evidence established in accordance with paragraph 2.2.1 that the goods and ancillary services to be supplied by the tenderer are eligible goods and services and conform to the tender documents; and
- (d) tender security furnished in accordance with paragraph 2.14
- (e) Confidential Business Questionnaire

2.9 Tender Forms

2.9.1 The tenderer shall complete the Tender Form and the appropriate Price Schedule furnished in the tender documents, indicating the goods to be supplied, a brief description of the goods, their country of origin, quantity, and prices.

2.10 Tender Prices

2.10.1 The tenderer shall indicate on the appropriate Price Schedule the unit prices and total tender price of the goods it proposes to supply under the contract.

2.10.2 Prices indicated on the Price Schedule shall include all costs including taxes, insurances and delivery to the premises of the entity.

2.10.3 Prices quoted by the tender shall remain fixed during the Tender's performance of the contract. A tender submitted with an adjustable price quotation will be treated as non-responsive and will be rejected, pursuant to paragraph 2.22 unless otherwise agreed by the parties.

2.10.4 The validity period of the tender shall be 150 days from the date of opening of the tender.

2.11 Tender Currencies

2.11.1 Prices shall be quoted in Kenya Shillings unless otherwise specified in the Appendix to Instructions to Tenderers.

2.12 Tenderers Eligibility and Qualifications

- 2.12.1 Pursuant to paragraph 2.1. the tenderer shall furnish, as part of its tender, documents establishing the tenderers eligibility to tender and its qualifications to perform the contract if its tender is accepted.
- 2.12.2 The documentary evidence of the tenderers eligibility to tender shall establish to the Procuring entity's satisfaction that the tenderer, at the time of submission of its tender, is from an eligible source country as defined under paragraph 2.1
- 2.12.3 The documentary evidence of the tenderers qualifications to perform the contract if its tender is accepted shall be established to the Procuring entity's satisfaction;
- (a) that, in the case of a tenderer offering to supply goods under the contract which the tenderer did not manufacture or otherwise produce, the tenderer has been duly authorized by the goods' Manufacturer or producer to supply the goods.
 - (b) that the tenderer has the financial, technical, and production capability necessary to perform the contract;
 - (c) that, in the case of a tenderer not doing business within Kenya, the tenderer is or will be (if awarded the contract) represented by an Agent in Kenya equipped, and able to carry out the Tenderer's maintenance, repair, and spare parts-stocking obligations prescribed in the Conditions of Contract and/or Technical Specifications.

2.13 Goods Eligibility and Conformity to Tender Documents

- 2.13.1 Pursuant to paragraph 2.2 of this section, the tenderer shall furnish, as part of its tender documents establishing the eligibility and conformity to the tender documents of all goods which the tenderer proposes to supply under the contract
- 2.13.2 The documentary evidence of the eligibility of the goods shall consist of a statement in the Price Schedule of the country of origin of the goods and services offered which shall be confirmed by a certificate of origin issued at the time of shipment.
- 2.13.3 The documentary evidence of conformity of the goods to the tender documents may be in the form of literature, drawings, and data, and shall consist of:
- (a) a detailed description of the essential technical and performance characteristic of the goods;
 - (b) a list giving full particulars, including available source and current prices of spare parts, special tools, etc., necessary for the proper and continuing functioning of the goods for a period of two (2) years, following commencement of the use of the goods by the Procuring entity; and
 - (c) a clause-by-clause commentary on the Procuring entity's Technical Specifications demonstrating substantial responsiveness of the goods and service to those specifications, or a statement of deviations and exceptions to the provisions of the Technical Specifications.

2.13.4 For purposes of the documentary evidence to be furnished pursuant to paragraph 2.13.3(c) above, the tenderer shall note that standards for workmanship, material, and equipment, as well as references to brand names or catalogue numbers designated by the Procurement entity in its Technical Specifications, are intended to be descriptive only and not restrictive. The tenderer may substitute alternative standards, brand names, and/or catalogue numbers in its tender, provided that it demonstrates to the Procurement entity's satisfaction that the substitutions ensure substantial equivalence to those designated in the Technical Specifications.

2.14 Tender Security

2.14.1 The tenderer shall furnish, as part of its tender, a tender security for the amount specified in the Appendix to Invitation to Tenderers.

2.14.2 The tender security shall be in the amount of 2 per cent of the tender price.

2.14.3 The tender security is required to protect the Procuring entity against the risk of Tenderer's conduct which would warrant the security's forfeiture, pursuant to paragraph 2.14.7

2.14.4 The tender security shall be denominated in Kenya Shillings or in another freely convertible currency, and shall be in the form of a bank guarantee or a bank draft issued by a reputable bank located in Kenya or abroad in the form provided in the tender documents or another form acceptable to the Procuring entity and valid for thirty (30) days beyond the validity of the tender.

2.14.5 Any tender not secured in accordance with paragraph 2.14.1 and 2.14.3 will be rejected by the Procuring entity as non-responsive, pursuant to paragraph 2.22

2.14.6 Unsuccessful Tenderer's tender security will be discharged or returned as promptly as possible as but not later than thirty (30) days after the expiration of the period of tender validity prescribed by the Procuring entity.

2.14.7 The successful Tenderer's tender security will be discharged upon the tenderer signing the contract, pursuant to paragraph 2.27 and furnishing the performance security, pursuant to paragraph 2.28

2.14.8 The tender security may be forfeited:

- (a) if a tenderer withdraws its tender during the period of tender validity specified by the procuring entity on the Tender Form; or
- (b) in the case of a successful tenderer, if the tenderer fails:
 - (i) to sign the contract in accordance with paragraph 2.27
 - or
 - (ii) to furnish performance security in accordance with paragraph 2.28
- c) If the tenderer rejects correction of an arithmetic error in the tender.

2.15 Validity of Tenders

2.15.1 Tenders shall remain valid for 150 days or as specified in the Invitation to Tender after the date of tender opening prescribed by the Procuring entity, pursuant to paragraph 2.18. A tender valid for a shorter period shall be rejected by the Procuring entity as non-responsive.

2.15.2 In exceptional circumstances, the Procuring entity may solicit the Tenderer's consent to an extension of the period of validity. The request and the responses thereto shall be made in writing. The tender security provided under paragraph 2.14 shall also be suitably extended. A tenderer may refuse the request without forfeiting its tender security. A tenderer granting the request will not be required nor permitted to modify its tender.

2.16 Format and Signing of Tender

2.16.1 The Procuring entity shall prepare two copies of the tender, clearly marking each "ORIGINAL TENDER" and "COPY OF TENDER," as appropriate. In the event of any discrepancy between them, the original shall govern.

2.16.2 The original and all copies of the tender shall be typed or written in indelible ink and shall be signed by the tenderer or a person or persons duly authorized to bind the tenderer to the contract. The latter authorization shall be indicated by written power-of-attorney accompanying the tender. All pages of the tender, except for unamended printed literature, shall be initialled by the person or persons signing the tender.

2.16.3 The tender shall have no interlineations, erasures, or overwriting except as necessary to correct errors made by the tenderer, in which case such corrections shall be initialled by the person or persons signing the tender.

2.17 Sealing and Marking of Tenders

2.17.1 The Tenderer shall seal the original and each copy of the tender in separate envelopes, duly marking the envelopes as "ORIGINAL" and "COPY." The envelopes shall then be sealed in an outer envelope.

2.17.2 The inner and outer envelopes shall:

- (a) be addressed to the Procuring entity at the address given in the Invitation to Tender:

bear, tender number and name in the Invitation for Tenders and the words, "DO NOT OPEN BEFORE," **12th February 2019 at 12.00a.m**

- 2.17.3 The inner envelopes shall also indicate the name and address of the tenderer to enable the tender to be returned unopened in case it is declared “late”.
- 2.17.4 If the outer envelope is not sealed and marked as required by paragraph 2.17.2, the Procuring entity will assume no responsibility for the tender’s misplacement or premature opening.

2.18 Deadline for Submission of Tenders

Tenders must be received by the Procuring entity at the address specified under paragraph 2.17.2 no later than **12th February 2019 at 12.00a.m**

- 2.18.1 The Procuring entity may, at its discretion, extend this deadline for the submission of tenders by amending the tender documents in accordance with paragraph 2.6, in which case all rights and obligations of the Procuring entity and candidates previously subject to the deadline will therefore be subject to the deadline as extended
- 2.18.2 Bulky tenders which will not fit I the tender box shall be received by the procuring entity as provided for in the Appendix.

2.19 Modification and Withdrawal of Tenders

- 2.19.1 The tenderer may modify or withdraw its tender after the tender’s submission, provided that written notice of the modification, including substitution or withdrawal of the tenders, is received by the Procuring prior to the deadline prescribed for submission of tenders.
- 2.19.2 The Tenderer’s modification or withdrawal notice shall be prepared, sealed, marked, and dispatched in accordance with the provisions of paragraph 2.17. A withdrawal notice may also be sent by cable, telex but followed by a signed confirmation copy, postmarked not later than the deadline for submission of tenders.
- 2.19.3 No tender may be modified after the deadline for submission of tenders.
- 2.19.4 No tender may be withdrawn in the interval between the deadline for submission of tenders and the expiration of the period of tender validity specified by the tenderer on the Tender Form. Withdrawal of a tender during this interval may result in the Tenderer’s forfeiture of its tender security, pursuant to paragraph 2.14.7
- 2.19.5 The procuring entity may at any time terminate procurement proceedings before contract award and shall not be liable to any person for the termination.
- 2.19.6 The procuring entity shall give prompt notice of the termination to the tenderers and on request give its reasons for termination within 14 days of receiving the request from any tenderer.

2.20 Opening of Tenders

The Procuring entity will open all tenders in the presence of tenderers' representatives who choose to attend, at **12th February 2019 at 12.00a.m**

2.20.1 . and in the location specified in the Invitation to Tender.

The tenderers' representatives who are presence shall sign a register evidencing their attendance.

2.20.2 The tenderers' names, tender modifications or withdrawals, tender prices, discounts and the presence or absence of requisite tender security and such other details as the Procuring entity, at its discretion, may consider appropriate, will be announced at the opening.

2.20.3 The Procuring entity will prepare minutes of the tender opening.

2.21 Clarification of Tenders

2.21.1 To assist in the examination, evaluation and comparison of tenders the Procuring entity may, at its discretion, ask the tenderer for a clarification of its tender. The request for clarification and the response shall be in writing, and no change in the prices or substance of the tender shall be sought, offered, or permitted.

2.21.2 Any effort by the tenderer to influence the Procuring entity in the Procuring entity's tender evaluation, tender comparison or contract award decisions may result in the rejection of the tenderers' tender.

2.22 Preliminary Examination

2.22.1 The Procuring entity will examine the tenders to determine whether they are complete, whether any computational errors have been made, whether required sureties have been furnished, whether the documents have been properly signed, and whether the tenders are generally in order.

2.22.2 Arithmetical errors will be rectified on the following basis. If there is a discrepancy between the unit price and the total price that is obtained by multiplying the unit price and quantify, the unit price shall prevail, and the total price shall be corrected. If the candidate does not accept the correction of the errors, its tender will be rejected, and its tender security forfeited. If there is a discrepancy between words and figures the amount in words will prevail

2.22.3 The Procuring entity may waive any minor informality or non-conformity or irregularity in a tender which does not constitute a material deviation, provided such waiver does not prejudice or effect the relative ranking of any tenderer.

2.22.4 Prior to the detailed evaluation, pursuant to paragraph 2.23 the Procuring entity will determine the substantial responsiveness of each tender to the tender documents. For purposes of these paragraphs, a substantially responsive tender is one, which conforms to all the terms and conditions of the tender documents without material deviations. The Procuring entity's determination of a tender's responsiveness is to be based on the contents of the tender itself without recourse to extrinsic evidence.

2.22.5 If a tender is not substantially responsive, it will be rejected by the Procuring entity and may not subsequently be made responsive by the tenderer by correction of the non-conformity.

2.23 Conversion to Single Currency

2.23.1 Where other currencies are used, the procuring entity will convert these currencies to Kenya Shillings using the selling exchange rate on the date of tender closing provided by the Central Bank of Kenya.

2.24 Evaluation and Comparison of Tenders

2.24.1 The Procuring entity will evaluate and compare the tenders which have been determined to be substantially responsive, pursuant to paragraph 2.22

2.24.2 The tender evaluation committee shall evaluate the tender within 30 days of the validity period from the date of opening the tender.

2.24.3 A tenderer who gives false information in the tender document about its qualification or who refuses to enter into a contract after notification of contract award shall be considered for debarment from participating in future public procurement.

2.24.4 The procuring entity's evaluation of a tender will take into account, in addition to the tender price and the price incidental services, the following factors, in the manner and to the extent indicated in paragraph 2.23.5 and in the technical specifications:

- a). Delivery and installation schedule offered in the tender;
- b). Deviations in payment schedule from the specifications in the special Conditions of Contract;
- c). The cost of components, mandatory spare parts and services;
- d). The availability in Kenya of spare parts and after – sale service for the goods offered in the tender;

2.24.5 The tender evaluation committee shall evaluate the tender within 30 days of the validity period from the date of opening the tender

2.25 Preference

2.25.1 Preference where allowed in the evaluation of tenders shall not exceed 15%

2.26 Contacting the Procuring entity

2.26.1 Subject to paragraph 2.21 no tenderer shall contact the Procuring entity on any matter related to its tender, from the time of the tender opening to the time the contract is awarded.

2.26.2 Any effort by a tenderer to influence the Procuring entity in its decisions on tender, evaluation, tender comparison, or contract award may result in the rejection of the Tenderer's tender.

2.27 Award of Contract

(a) Post-qualification

- 2.27.1 In the absence of pre-qualification, the Procuring entity will determine to its satisfaction whether the tenderer that is selected as having submitted the lowest evaluated responsive tender is qualified to perform the contract satisfactorily.
- 2.27.2 The determination will take into account the tenderer financial, technical, and production capabilities. It will be based upon an examination of the documentary evidence of the tenderers qualifications submitted by the tenderer, pursuant to paragraph 2.12.3 as well as such other information as the Procuring entity deems necessary and appropriate.
- 2.27.3 An affirmative determination will be a prerequisite for award of the contract to the tenderer. A negative determination will result in rejection of the Tenderer's tender, in which event the Procuring entity will proceed to the next lowest evaluated tender to make a similar determination of that Tenderer's capabilities to perform satisfactorily.

(b) Award Criteria

- 2.27.4 The Procuring entity will award the contract to the successful tenderer(s) whose tender has been determined to be substantially responsive and has been determined to be the lowest evaluated tender, provided further that the tenderer is determined to be qualified to perform the contract satisfactorily.
- 2.27.5 To qualify for contract awards, the tenderer shall have the following:
- a) Necessary qualifications, capability experience, services, equipment and facilities to provide what is being procured.
 - b) Legal capacity to enter into a contract for procurement
 - c) Shall not be insolvent, in receivership, bankrupt or in the process of being wound up and is not the subject of legal proceedings relating to the foregoing.
 - d) Shall not be debarred from participating in Public Procurement.

(c) Procuring entity's Right to Vary quantities

- 2.27.6 The Procuring entity reserves the right at the time of contract award to increase or decrease the quantity of goods originally specified in the Schedule of requirements without any change in unit price or other terms and conditions

(d) Procuring entity's Right to Accept or Reject Any or All Tenders

- 2.27.7 The Procuring entity reserves the right to accept or reject any tender, and to annul the tendering process and reject all tenders at any time prior to contract award, without thereby incurring any liability to the affected tenderer or tenderers or any obligation to inform the affected tenderer or tenderers of the grounds for the Procuring entity's action

- 2.27.8 The procuring entity may at any time terminate procurement proceedings before contract award and shall not be liable to any person for the termination
- 2.27.9 The procuring entity shall give prompt notice of the termination to the tenderers and on request give its reasons for termination within 14 days of receiving the request from any tenderer
- 2.27.10A tenderer who gives false information in the tender document about its qualification or who refuses to enter into a contract after notification of contract award shall be considered for debarment from participating in future Public Procurement

2.28 Notification of Award

- 2.28.1 Prior to the expiration of the period of tender validity, the Procuring entity will notify the successful tenderer in writing that its tender has been accepted.
- 2.28.2 The notification of award will constitute the formation of the Contract but will have to wait until the contract is finally signed by both parties. Simultaneous other tenderers shall be notified that their tenders have not been successful.
- 2.28.3 Upon the successful Tenderer's furnishing of the performance security pursuant to paragraph 2.30, the Procuring entity will simultaneously inform the other tenderers that their tenders have not been successful.

2.29 Signing of Contract

- 2.29.1 At the same time as the Procuring entity notifies the successful tenderer that its tender has been accepted, the Procuring entity will send the tenderer the Contract Form provided in the tender documents, incorporating all agreements between the parties.
- 2.29.2 Within fourteen (14) days of receipt of the Contract Form, the successful tenderer shall sign and date the contract and return it to the Procuring entity
- 2.29.3 The parties to the contract shall have it signed within 30 days from the date of notification of contract award unless there is an administrative review request.

2.30 Performance Security

- 2.30.1 Within Thirty (30) days of the receipt of notification of award from the Procuring entity, the successful tenderer shall furnish the performance security in accordance with the Conditions of Contract, in the Performance Security Form provided in the tender documents, or in another form acceptable to the Procuring entity.
- 2.30.2 Failure of the successful tenderer to comply with the requirements of paragraph 2.27 or paragraph 2.28 shall constitute sufficient grounds for the annulment of the award and forfeiture of the tender security, in which event the Procuring entity may make the award to the next lowest evaluated Candidate or call for new tenders.

2.31 Corrupt or Fraudulent Practices

2.31.1 The Procuring entity requires that tenderers observe the highest standard of ethics during the procurement process and execution of contracts when used in the present regulations, the following terms are defined as follows;

- (i) “corrupt practice” means the offering, giving, receiving, or soliciting of any thing of value to influence the action of a public official in the procurement process or in contract execution; and

2.31.2 “fraudulent practice” means a misrepresentation of facts in order to influence a procurement process or the execution of a contract to the detriment of the Procuring entity, and includes collusive practice among tenderer (prior to or after tender submission) designed to establish tender prices at artificial non-competitive levels and to deprive the Procuring entity of the benefits of free and open competition; The procuring entity will reject a proposal for award if it determines that the tenderer recommended for award has engaged in corrupt or fraudulent practices in competing for the contract in question.

2.31.3 Further a tenderer who is found to have indulged in corrupt or fraudulent practices risks being debarred from participating in public procurement in Kenya.

APPENDIX TO INSTRUCTIONS TO TENDERERS

The following information regarding the particulars of the tender shall complement supplement or amend the provisions of the instructions to tenderers. Wherever there is a conflict between the provision of the instructions to tenderers and the provisions of the appendix, the provisions of the appendix herein shall prevail over those of the instructions to tenderers

Instructions To Tenderers	Particulars of appendix to Instructions to Tenderers
2.1	<i>Price to be charged for tender documents:</i> Downloaded free of charge
2.10	<i>Particulars of other currencies allowed:</i> None
2.11	<i>Particulars of eligibility and qualifications documents of evidence required.</i> Copies of: i) Certificate of Registration ii) Certificate of Valid Tax Compliance iii) Form of Tender iv) Fully filled Confidential Business Questionnaire
2.14.1	<i>Particulars of tender security if applicable:</i>
2.14.2	The acceptable Bid Bond will be Bank Guarantee from a reputable bank and such Insurance Guarantee from Insurance Companies approved by the Public Procurement Regulatory Authority (PPRA)
2.15	<i>Validity of Tender:</i> tenders shall remain valid for 150 days from the date of tender opening

Instructions To Tenderers	Particulars of appendix to Instructions to Tenderers																									
2.24	<p>b) Technical Scores (T.S)</p> <p>This section (Technical Evaluation) will carry a total of 80% of the whole evaluation</p> <table border="1"> <thead> <tr> <th>No.</th> <th>Evaluation Attribute</th> <th>Tenderer's Response</th> <th>Weighing Score</th> <th>Max. Score</th> </tr> </thead> <tbody> <tr> <td>T.S.1</td> <td>Prove of similar works of the same nature</td> <td></td> <td> <ul style="list-style-type: none"> 5yrs and above (20marks) Below 5yrs (each year to earn 4 marks) </td> <td>20</td> </tr> <tr> <td>T.S.2</td> <td>Provide evidence of projects undertaken. Provide copies of LSOs/Contracts/Letters of reference and names of clients</td> <td></td> <td> <ul style="list-style-type: none"> 5 or more projects (evidence with references) – 20marks </td> <td>20</td> </tr> <tr> <td>T.S.3</td> <td>Financial Strength: Provide audited accounts for the immediate preceding three years (2016 & 2017) and credit line</td> <td></td> <td> Audited accounts <ul style="list-style-type: none"> 2 years – 10marks 1 year – 5 marks Credit Line – 10 marks </td> <td>20</td> </tr> <tr> <td>T.S.4</td> <td> <ul style="list-style-type: none"> Evidence of equipment to undertake the work (owned or hired) </td> <td></td> <td> <ul style="list-style-type: none"> Log books – 20 marks Hired – </td> <td>20</td> </tr> </tbody> </table>	No.	Evaluation Attribute	Tenderer's Response	Weighing Score	Max. Score	T.S.1	Prove of similar works of the same nature		<ul style="list-style-type: none"> 5yrs and above (20marks) Below 5yrs (each year to earn 4 marks) 	20	T.S.2	Provide evidence of projects undertaken. Provide copies of LSOs/Contracts/Letters of reference and names of clients		<ul style="list-style-type: none"> 5 or more projects (evidence with references) – 20marks 	20	T.S.3	Financial Strength: Provide audited accounts for the immediate preceding three years (2016 & 2017) and credit line		Audited accounts <ul style="list-style-type: none"> 2 years – 10marks 1 year – 5 marks Credit Line – 10 marks 	20	T.S.4	<ul style="list-style-type: none"> Evidence of equipment to undertake the work (owned or hired) 		<ul style="list-style-type: none"> Log books – 20 marks Hired – 	20
No.	Evaluation Attribute	Tenderer's Response	Weighing Score	Max. Score																						
T.S.1	Prove of similar works of the same nature		<ul style="list-style-type: none"> 5yrs and above (20marks) Below 5yrs (each year to earn 4 marks) 	20																						
T.S.2	Provide evidence of projects undertaken. Provide copies of LSOs/Contracts/Letters of reference and names of clients		<ul style="list-style-type: none"> 5 or more projects (evidence with references) – 20marks 	20																						
T.S.3	Financial Strength: Provide audited accounts for the immediate preceding three years (2016 & 2017) and credit line		Audited accounts <ul style="list-style-type: none"> 2 years – 10marks 1 year – 5 marks Credit Line – 10 marks 	20																						
T.S.4	<ul style="list-style-type: none"> Evidence of equipment to undertake the work (owned or hired) 		<ul style="list-style-type: none"> Log books – 20 marks Hired – 	20																						

				10 marks	
	T.S.5	Provide company profile and Organization Chart		If the provided – 10 marks If not – 0 marks	10
	T.S.6	Provide relevant NCA		If the provided – 10 marks If not – 0 marks	10
Only bidders who score 75% and above will be subjected to Financial Evaluation. Those who score below 75% will be eliminated at this stage from the entire evaluation process and will not be considered further.					

Instructions To Tenderers	Particulars of appendix to Instructions to Tenderers
2.26 (b)	<i>Award criteria:</i> Award will be made to the bidder with the highest combined scores
2.29.1	<i>Indicate particulars of performance security:</i>
Other's as necessary	<i>Complete as necessary:</i> None

SECTION III: GENERAL CONDITIONS OF CONTRACT

Table of Clauses

	Page
3.1 Definitions.....	20
3.2 Application.....	20
3.3 Country of Origin.....	20
3.4 Standards.....	20
3.5 Use of Contract documents and information.....	20
3.6 Patent Rights.....	21
3.7 Performance security.....	21
3.8 Inspection and Tests.....	21
3.9 Packing.....	22
3.10 Delivery and documents.....	22
3.11 Insurance	22
3.12 Payment.....	22
3.13 Price.....	23
3.14 Assignments.....	23
3.15 Sub contracts.....	23
3.16 Termination for default.....	23
3.17 Liquidated damages.....	24
3.18 Resolution of Disputes.....	24
3.19 Language and law.....	24
3.20 Force Majeure.....	24
3.21 Notices.....	24

SECTION III - GENERAL CONDITIONS OF CONTRACT

3.1 Definitions

3.1.1 In this Contract, the following terms shall be interpreted as indicated:-

- (a) “The Contract” means the agreement entered into between the Procuring entity and the tenderer, as recorded in the Contract Form signed by the parties, including all attachments and appendices thereto and all documents incorporated by reference therein.
- (b) “The Contract Price” means the price payable to the tenderer under the Contract for the full and proper performance of its contractual obligations
- (c) “The Goods” means all of the equipment, machinery, and/or other materials, which the tenderer is required to supply to the Procuring entity under the Contract.
- (d) “The Procuring entity” means the organization purchasing the Goods under this Contract.
- (e) “The Tenderer” means the individual or firm supplying the Goods under this Contract.

3.2 Application

3.2.1 These General Conditions shall apply in all Contracts made by the Procuring entity for the procurement installation and commissioning of equipment to the extent that they are not superceded by provisions of other part of contract.

3.3 Country of Origin

- 3.3.1 For purposes of this clause, “Origin” means the place where the Goods were mined, grown or produced.
- 3.3.2 The origin of Goods and Services is distinct from the nationality of the tenderer and will be treated thus in the evaluation of the tender.

3.4 Standards

3.4.1 The Goods supplied under this Contract shall conform to the standards mentioned in the Technical Specifications.

3.5 Use of Contract Documents and Information

3.5.1 The tenderer shall not, without the Procuring entity’s prior written consent, disclose the Contract, or any provision therefore, or any specification, plan, drawing, pattern, sample, or information furnished by or on behalf of the Procuring entity in connection therewith, to any person other than a person employed by the tenderer in the performance of the Contract.

3.5.2 The tenderer shall not, without the Procuring entity's prior written consent, make use of any document or information enumerated in paragraph 3.5.1 above

3.5.3 Any document, other than the Contract itself, enumerated in paragraph 3.5.1 shall remain the property of the Procuring entity and shall be returned (all copies) to the Procuring entity on completion of the Tenderer's performance under the Contract if so required by the Procuring entity

3.6 **Patent Rights**

3.6.1 The tenderer shall indemnify the Procuring entity against all third-party claims of infringement of patent, trademark, or industrial design rights arising from use of the Goods or any part thereof in the Procuring entity's country

3.7 **Performance Security**

3.7.1 Within thirty (30) days of receipt of the notification of Contract award, the successful tenderer shall furnish to the Procuring entity the performance security in the amount specified in Special Conditions of Contract.

3.7.2 The proceeds of the performance security shall be payable to the Procuring entity as compensation for any loss resulting from the Tenderer's failure to complete its obligations under the Contract.

3.7.3 The performance security shall be denominated in the currency of the contract, or in a freely convertible currency acceptable to the procuring entity and shall be in the form of

- a) Cash
- b) Bank guarantee
- c) Such Insurance guarantee approved by the authority
- d) Letter of credit

3.7.4 The performance security shall be denominated in the currency of the Contract, or in a freely convertible currency acceptable to the Procuring entity and shall be in the form of a bank guarantee or an irrevocable letter of credit issued by a reputable bank located in Kenya or abroad, acceptable to the Procuring entity, in the form provided in the tender documents.

3.7.5 The performance security will be discharged by the Procuring entity and returned to the Candidate not later than thirty (30) days following the date of completion of the Tenderer's performance obligations under the Contract, including any warranty obligations, under the Contract

3.8 **Inspection and Tests**

3.8.1 The Procuring entity or its representative shall have the right to inspect and/or to test the goods to confirm their conformity to the Contract specifications. The Procuring entity shall notify the tenderer in writing in a timely manner, of the identity of any representatives retained for these purposes.

3.8.2 The inspections and tests may be conducted in the premises of the tenderer or its subcontractor(s), at point of delivery, and/or at the Goods' final destination If conducted

on the premises of the tenderer or its subcontractor(s), all reasonable facilities and assistance, including access to drawings and production data, shall be furnished to the inspectors at no charge to the Procuring entity.

3.8.3 Should any inspected or tested goods fail to conform to the Specifications, the Procuring entity may reject the equipment, and the tenderer shall either replace the rejected equipment or make alternations necessary to make specification requirements free of costs to the Procuring entity.

3.8.4 The Procuring entity's right to inspect, test and where necessary, reject the goods after the Goods' arrival shall in no way be limited or waived by reason of the equipment having previously been inspected, tested and passed by the Procuring entity or its representative prior to the equipment delivery.

3.8.5 Nothing in paragraph 3.8 shall in any way release the tenderer from any warranty or other obligations under this Contract.

3.9 **Packing**

3.9.1 The tenderer shall provide such packing of the Goods as is required to prevent their damage or deterioration during transit to their final destination, as indicated in the Contract.

3.9.2 The packing, marking, and documentation within and outside the packages shall comply strictly with such special requirements as shall be expressly provided for in the Contract

3.10 **Delivery and Documents**

3.10.1 Delivery of the Goods shall be made by the tenderer in accordance with the terms specified by Procuring entity in its Schedule of Requirements and the Special Conditions of Contract

3.11 **Insurance**

3.11.1 The Goods supplied under the Contract shall be fully insured against loss or damage incidental to manufacturer or acquisition, transportation, storage, and delivery in the manner specified in the Special conditions of contract.

3.12 **Payment**

3.12.1 The method and conditions of payment to be made to the tenderer under this Contract shall be specified in Special Conditions of Contract

3.12.2 Payments shall be made promptly by the Procuring entity as specified in the contract

3.13 Prices

- 3.13.1 Prices charged by the tenderer for goods delivered and services performed under the Contract shall not, with the exception of any price adjustments authorized in Special Conditions of Contract, vary from the prices by the tenderer in its tender.
- 3.13.2 Contract price variations shall not be allowed for contracts not exceeding one year (12 months)
- 3.13.3 Where contract price variation is allowed, the variation shall not exceed 10% of the original contract price.
- 3.13.4 Price variation request shall be processed by the procuring entity within 30 days of receiving the request.

3.14. Assignment

- 3.14.1 The tenderer shall not assign, in whole or in part, its obligations to perform under this Contract, except with the Procuring entity's prior written consent

3.15 Subcontracts

- 3.15.1 The tenderer shall notify the Procuring entity in writing of all subcontracts awarded under this Contract if not already specified in the tender. Such notification, in the original tender or later, shall not relieve the tenderer from any liability or obligation under the Contract

3.16 Termination for default

- 3.16.1 The Procuring entity may, without prejudice to any other remedy for breach of Contract, by written notice of default sent to the tenderer, terminate this Contract in whole or in part
 - (a) if the tenderer fails to deliver any or all of the goods within the periods specified in the Contract, or within any extension thereof granted by the Procuring entity
 - (b) if the tenderer fails to perform any other obligation(s) under the Contract
 - (c) if the tenderer, in the judgment of the Procuring entity has engaged in corrupt or fraudulent practices in competing for or in executing the Contract
- 3.16.2 In the event the Procuring entity terminates the Contract in whole or in part, it may procure, upon such terms and in such manner as it deems appropriate, equipment similar to those undelivered, and the tenderer shall be liable to the Procuring entity for any excess costs for such similar goods.

3.17 Liquidated Damages

- 3.17.1. If the tenderer fails to deliver any or all of the goods within the period(s) specified in the contract, the procuring entity shall, without prejudice to its other remedies under the contract, deduct from the contract prices liquidated damages sum equivalent to 0.5% of the delivered price of the delayed items up to a maximum deduction of 10% of the delayed goods. After this the tenderer may consider termination of the contract.

3.18 Resolution of Disputes

- 3.18.1 The procuring entity and the tenderer shall make every effort to resolve amicably by direct informal negotiation and disagreement or dispute arising between them under or in connection with the contract
- 3.18.2 If, after thirty (30) days from the commencement of such informal negotiations both parties have been unable to resolve amicably a contract dispute, either party may require that the dispute be referred for resolution to the formal mechanism specified in the SCC

3.19 Language and Law

- 3.19.1 The language of the contract and the law governing the contract shall be English language and the Laws of Kenya respectively unless otherwise specified in the SCC

3.20 Force Majeure

- 3.20.1 The tenderer shall not be liable for forfeiture of its performance security or termination for default if and to the extent that it's delay in performance or other failure to perform its obligations under the Contract is the result of an event of Force Majeure.

3.21 Notices

- 3.21.1 Any notice given by one party to the other pursuant to this contract shall be sent to other party by post or by fax or email and confirmed in writing to the other party's address specified.
- 3.21.2 A notice shall be effective when delivered or on the notice effective date, whichever is later.

SECTION IV - SPECIAL CONDITIONS OF CONTRACT

4.1. Special Conditions of Contract shall supplement the General Conditions of Contract. Whenever there is a conflict, between the GCC and the SCC, the provisions of the SCC herein shall prevail over these in the GCC.

42. Special conditions of contract as relates to the GCC

REQUIREMENT	SPECIAL CONDITIONS OF CONTRACT
Tender Security	
Performance Security	
Payment Terms	60 days upon completion of the project
Delivery Schedule	
Tenders Closing Date	12th February 2019 at 12.00a.m
Submission of Dispute	Through IFMIS

SECTION V - SCHEDULE OF REQUIREMENTS

Number	Description	Quantity	Delivery schedule (shipment) In Weeks/months from Date of Signing Agreement

SECTION VI- TECHNICAL SPECIFICATIONS

6.1 General

- 6.1.1 These specifications describe the requirements for goods. Tenderers are requested to submit with their offers the detailed specifications, drawings, catalogues, etc for the products they intend to supply
- 6.1.2 Tenderers must indicate on the specifications sheets whether the equipment offered comply with each specified requirement.
- 6.1.3 All the dimensions and capacities of the equipment to be supplied shall not be less than those required in these specifications. Deviations from the basic requirements, if any shall be explained in detail in writing with the offer, with supporting data such as calculation sheets, etc. The procuring entity reserves the right to reject the products, if such deviations shall be found critical to the use and operation of the products.
- 6.1.4 The tenderers are requested to present information along with their offers as follows:
- (i) Shortest possible delivery period of each product
 - (ii) Information on proper representative and/or workshop for back-up service/repair and maintenance including their names and addresses.

DRAWINGS

FIGURE C11- HEADWALL TYPE 1 (HEAD AND WINGWALLS)

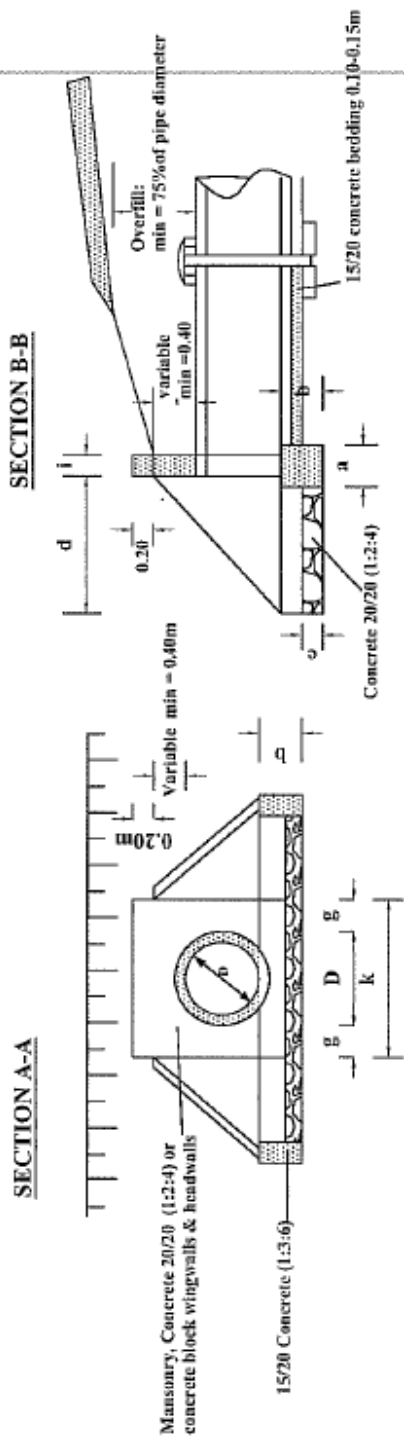

PLAN

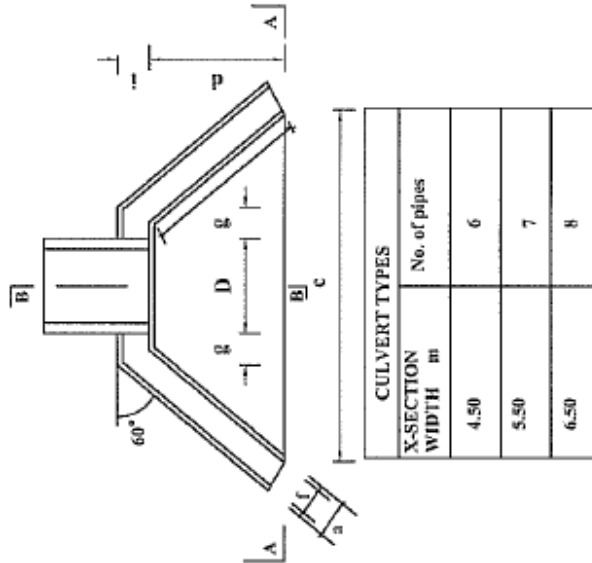

PIPE DIAMETER IN M	TYPE A and C CONCRETE BLOCKS MASONRY			TYPE B (STONE MASONRY)		
	450	600	900	450	600	900
DIMENSION UNIT						
a FOUNDATION m	0.30	0.30	0.30	0.40	0.40	0.60
b FOUNDATION m	0.30	0.30	0.40	0.30	0.30	0.40
c FOUNDATION m	2.20	2.35	2.89	2.20	2.35	2.89
d APRON m	1.00	1.00	1.20	1.00	1.00	1.20
e APRON m	0.20	0.20	0.20	0.20	0.20	0.20
f WALL m	0.20	0.20	0.20	0.40	0.40	0.40
g WALL m	0.30	0.30	0.30	0.30	0.30	0.30
h WALL m	1.15	1.15	1.39	1.15	1.15	1.39
i WALL m	0.20	0.20	0.20	0.40	0.40	0.40
k APRON m	1.05	1.20	1.50	1.05	1.20	1.50
MATERIAL REQUIREMENT						
FOUNDATION						
(concrete)	m3	0.30	0.32	0.51	0.40	1.03
HEAD/WINGWALLS						
(Concrete/Masonry)	m3	0.42	0.49	0.70	0.84	1.40
APRON	m3	0.33	0.36	0.53	0.33	0.53
(concrete)						

**PROFILE III
(CONCRETE)**

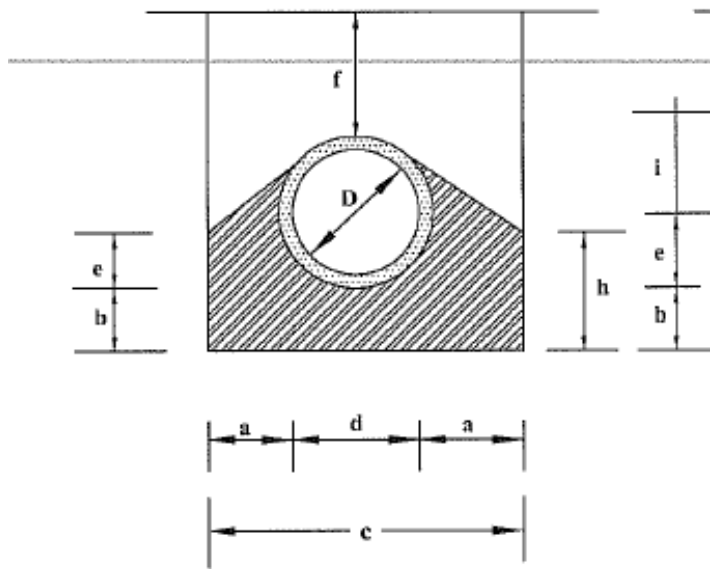

**PROFILE IV
(CONCRETE)**

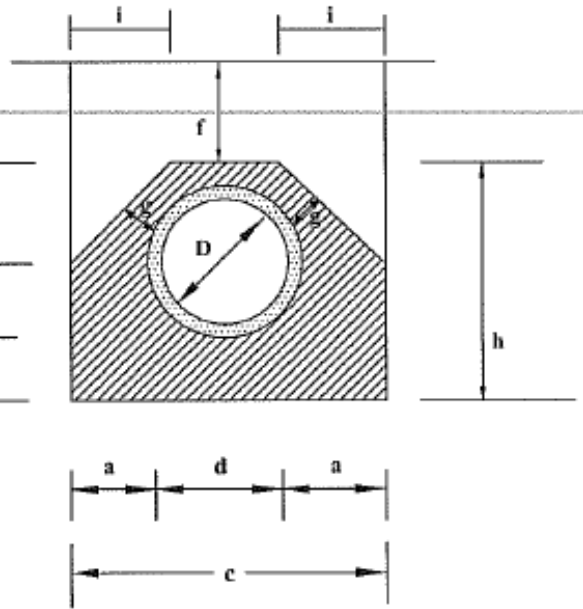

Diameter (D)	450 (mm)	600 (mm)	900 (mm)
a	0.15	0.20	0.20
b	0.10	0.15	0.15
c	0.86	1.12	1.48
d	0.56	0.72	1.08
e	0.42	0.54	0.81
f(min)	0.23	0.3	0.45
g	-	-	-
h	0.52	0.69	0.96
i	-	-	-
Concrete	Volume in (m³/m)		
Class 15/20	0.26	0.47	0.71
Application	-Fair subgrade condition -Overfill > 75% of the pipe diameter -Seasonal water flow only		
Remarks	Material for back/overfill shall be approved by the Engineer		

Diameter (D)	450 (mm)	600 (mm)	900 (mm)
a	0.15	0.20	0.20
b	0.10	0.15	0.15
c	0.86	1.12	1.48
d	0.56	0.72	1.08
e	0.46	0.52	0.78
f	0.15	0.15	0.15
g	0.15	0.15	0.15
h	0.81	1.02	1.38
i	0.28	0.35	0.45
Concrete	Volume in (m³/m)		
Class 15/20	0.37	0.61	0.92
Application	-Fair to poor subgrade condition -Overfill > 75% of the pipe diameter -Seasonal water flow only		
Remarks	Material for back/overfill shall be approved by the Engineer		

FIGURE C.1 - CROSS SECTION A (MINOR STANDARD CROSS-SECTION)

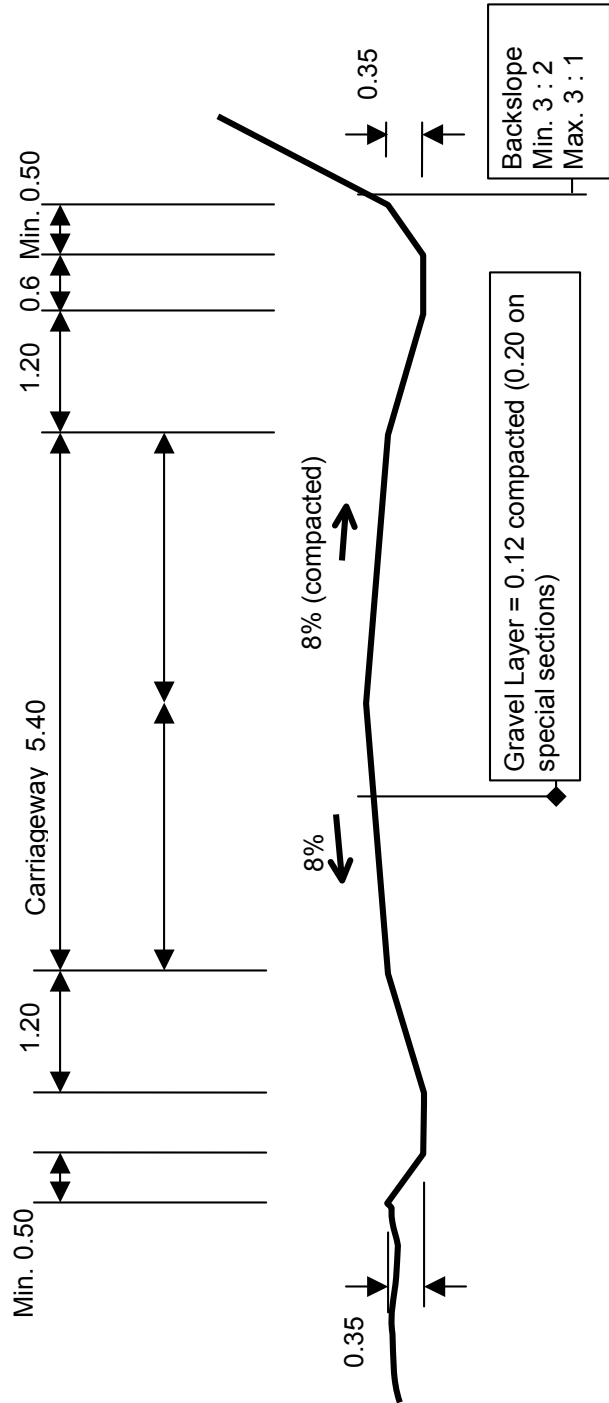

NOTE:

- ALL SPECIFIED DIMENSIONS IN m.
- TRAFFIC LEVELS OF MORE THAN 200 VPD MAY JUSTIFY RUNNING SURFACE WIDTH INCREASE TO 6.50 METRES

FIGURE C.2 - CROSS SECTION B (REDUCED CROSS-SECTION)

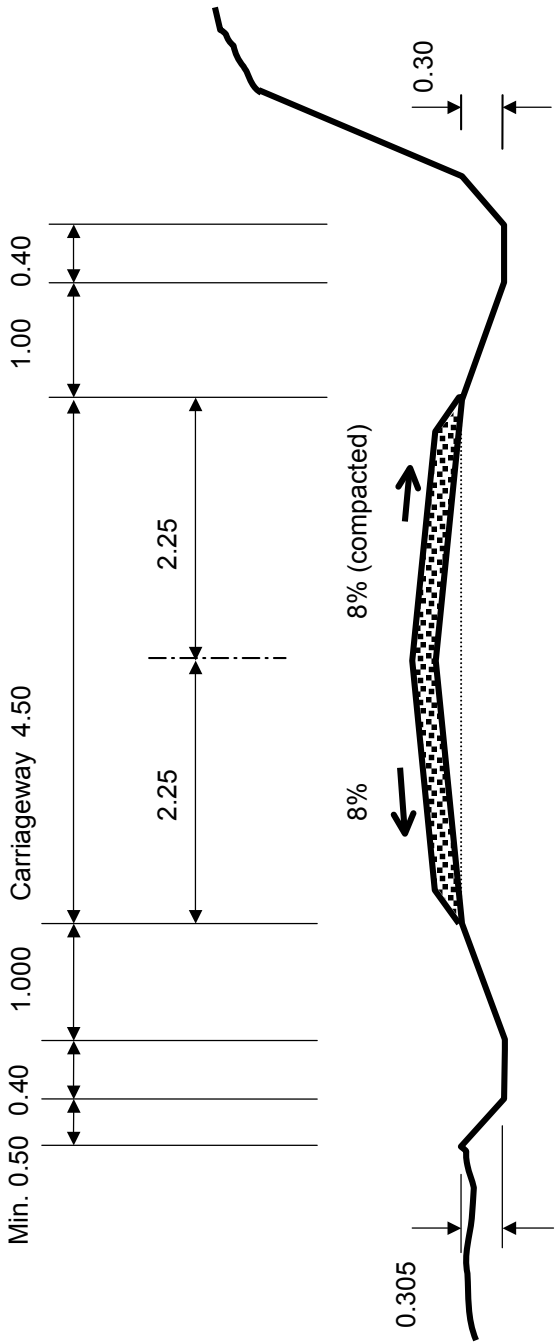

ANNEX 2: BILLS OF QUANTITIES

(NB: All Unit Rates should be VAT exclusive, calculate the VAT in the summary page)

CGN/RTPW/109/R/2017/2018: ROUTINE MAINTENANCE AND SPOT IMPROVEMENT OF K.T.D.A -RIPRIE ROAD IN KIPTAGICH WARD - KURESOI SOUTH SUB COUNTY

Item	Description	Unit	Qty	Rate	Amount
1	<u>BILL NO. 1: GENERAL</u>				
01-80-026	PC Sum of ksh 120 000 for the resident Engineer's miscellaneous account.	PC Sum	1		120,000
01-80-027	include % of PC sum in item 1.09 for contractor's overhead and profit	%	120000		
01-80-010	PC sum for off-site material testing.	PC Sum	1		20,000
01-80-011	include % of PC sum in item 1:11 for contractor's overhead and profit	%	20000		
01-80-012	pc sum for removal and reinstatement of services	PC Sum	1		5,000
01-80-013	include % of PC sum in item 1:11 for contractor's overhead and profit	%	5000		
01-80-016	Provide and maintain publicity signs as directed by the Engineer in accordance with MoR&PW drawing No.SS/234	No.	1		20,000
01-80-030	PC Sum for attendance to the Engineer's site staff	PC Sum	1		20,000
01-80-031	include % of PC sum in item 1:22 for contractor's overhead and profit	%	20000		
01-80-042d	Pc sum for Survey Works and Bqs Preparation	PC Sum	1		10,000
	TOTAL BIL 1				
	<u>BILL 4: SITE CLEARANCE AND TOPSOIL STRIPPING</u>				
04-60-001	Clear site on road reserve including removal of trees, hedges, bushes and other vegetation	m ²	10000		
04-60-002	Remove top soil to maximum depth of 200mm as directed by the Engineer stockpile good material for later top soiling of slide slopes and landscaping of quarries and borrow pits	m ²			
05-60-006	Selected materials for improved sub grade of minimum soils class S3 (CBR 10): dump, spread, water, mix and compact to 100% (MDD AASHTO T.99) as per specification	m ³			
	TOTAL BIL 4				

5	<u>BILL 5: EARTHWORKS</u>				
05-60-003	Compaction of top 300mm below formation in cuts and fills to 100% MDD	m ³			
05-50-016	Scarify water and compact existing ground to at least 95%MDD(AASHTO T99) to a depth of 150mm below ground level.	m ²	0	0	-
	TOTAL BIL 5				-
7	<u>BILL7: EXCAVATION AND FILLING FOR STRUCTURES</u>				
07-50-001	Excavation in soft material for major structures i.e. box culverts and gabion works.	m ³			
07-50-002	Excavate for structure in hard material	m ³			
07-60-002	Provide and place macaferra or equivalent gabion boxes and mattresses as specified.				
07-60-003	Provide and place rockfill to gabions.	m ³			
07-60-012	Provide stone pitching as directed by the Engineer.	m ²			-
07-60-011	cement grouting as directed by the Engineer.				
07-60-013	Provide,place and compact rockfill below structures as directed by the Engineer				
07-60-010	provide and place porous fill material behind wingwalls	m ³			
	TOTAL BIL 7				-
8	<u>BILL8: CULVERTS AND DRAINAGE WORKS</u>				
08-50-034	Excavate/desilt, grade to shape inlets outfalls, side drains to free flow conditions including cart to spoil any excess grass debris and soils as and where directed by the engineer.	m ³			-
08-90-012	Clean culverts to free flow condition.	m	80		
08-60-030	Excavate for inlet, outfall, mitre and catchwater drains in soft material.	m ³	100		
08-90-003	Excavate in soft materials for pipe culverts,headwalls wingwalls,apron,toewalls an drop inlets	m ³	70		
08-90-006	Provide,lay and joint 600mm inner diameter(ID) precast concrete pipes	m	36		
08-90-008	Provide place and compact class 15/20 concrete to beds,surrounds and	m ³	15		

	haunches.				
08-60-036	Provide place and compact class 25/20 concrete to headwalls, wingwalls, aprons and toe walls to pipe culverts including formwork.	m ³	7		
	TOTAL BIL 8				
11	<u>BILL 11: SHOULDER TO PAVEMENT</u>				
11-50-001	Prepare surface of existing road by grading with motor grader and dozing where necessary without compaction in accordance with the specification and as directed by the Engineer.	m ²	54,000		
	TOTAL BIL 11				
12	<u>BILL 12: NATURAL MATERIAL BASE AND SUBBASE</u>				
12-50-001	Provide, lay and compact Hand packed stone material including fillings voids with stone dust as directed by the Engineer.	m ³	0		
12-50-002	Provide and compact natural gravel of CBR greater than 30% or any other approved similar material as directed by the Engineer.	m ³	1,736		
	TOTAL BIL 12				
	BILL 14: CEMENT AND LIME TREATED MATERIAL				
14-50-001	Provide, transport to site and spread cement on natural gravel or GCS material for base or subbase as specified and as directed by the Engineer AT 30-90 kg/m ³	Kgs			-
	TOTAL BILL 14				-
	BILL 15: BITUMINOUS SURF. TREAT. & DRESSING				
15-92-001	Prepare surface of carriageway, bus bays and repair areas, provide and spray MC-30 cut back bitumen at a rate of 0.8-1.2 lt/m ² as prime coat.	Ltrs			-
15-92-003	Prepare surface of repair areas provide and spray k1-60 bitumen emulsion as tackcoat or seal to seal to repair areas at a spray rate of 0.8-1.0/square metre as directed by the engineer.	Ltrs			-
	TOTAL BILL 15				-

	BILL 16:BITUMINOUS MIXES				
16-80-001	Provide,place and compact asphalt concrete Type 1 with 5-6% nominal bitumen content by weight to total mix as wearing course on carriageway as directed by the Engineer.	m ³			-
16-80--008	Provide,place and compact asphaltic concrete Type 1 to repair areas and for regulation to carriageway as directed by the Engineer.	m ³			
16-80-002	Provide,place and compact dense bitumen macadam(DBM) with 3.0-4.5% nominal bitumen content by weight of total mix or as base on reconstruction sections as directed by the Enginner	m ³			
	TOTAL BILL 16				-
17	<u>BILL 17: CONCRETE WORKS</u> <u>CONCRETE</u>				
17-80-001	Class 15/20 for blinding	m ³			
17-80-002	Class 25/20 concrete	m ³			
	TOTAL BIL 17				
	BILL 20: ROAD FURNITURE				
20-50-007	Provide approved refractorised white paint and paint 100 mm wide white lines at the road edge as directed by the Engineer.	m ²			-
20-50-006	Approved refractorised yellow paint and paint 100mm wide yellow centre lines on the road as directed by the ehgineer.	m ²			-
20-50-019	Provide and place reflectors(cateyes) as instructed.	No.			
20-50-020	provide and erect permanent road signs where instructed by the engineer and in accordance with the specifications as follows;				
	(a) Warning signs	No.			-
	(b) Standard informatory signs.	No.			-
17-80-003	Place and provide class 20/20 concrete Bollards size 1.2xx2x0.2 embedded to a depth of 0.3 m at place and as directed by the Engineer.	No.			

20-50-012	excavate for lay and joint 250mm by 125mm P.C.C. Kerbs bedded and n a 1;3 cement mortar and laid on 225mm by 100mm bed haunched by 100mm and 125 mass concrete class20/20. Rates to include carting away to spoil and watering for curing at least seven days	M			-
	Supply lay 60mm thick paving block and vibrate with a plate compactor to the satisfaction of the engineer	M ²			-
	TOTAL BILL 20				-

SUMMARY	
TOTAL BILL 1	
TOTAL BILL 4	
TOTAL BILL 5	-
TOTAL BILL 7	-
TOTAL BILL 8	
TOTAL BILL 11	
TOTAL BILL 12	
TOTAL BILL 15	-
TOTAL BILL 16	-
TOTAL BILL 17	-
TOTAL BILL 20	-
TOTAL 1	
ADD 16% VAT	
TOTAL CARRIED TO FORM OF TENDER	

WORK PROGRAMME

CONTRACT PERIOD:

ACTIVITY IN WEEKS AS PER THE BILL OF QUANTITIES

ACTIVITY/WEEKS	WEEKS						

SECTION VII - PRICE SCHEDULE FOR GOODS

Name of tenderer _____ Tender Number _____ Page _____ of _____

1	2	3	4	5	6	7
Item	Description	Country of origin	Quantity	Unit price	Total Price EXW per item (cols. 4x5)	Unit price of other incidental services payable

Signature of tenderer _____

Note: In case of discrepancy between unit price and total, the unit price shall prevail.

SECTION VIII - STANDARD FORMS

Notes on the sample Forms

1. **Form of Tender** - The form of tender must be completed by the tenderer and submitted with the tender documents. It must also be duly signed by duly authorized representatives of the tenderer.
2. **Confidential Business Questionnaire Form** - This form must be completed by the tenderer and submitted with the tender documents.
3. **Tender Security Form** - When required by the tender documents the tender shall provide the tender security either in the form included herein or in another format acceptable to the procuring entity.
4. **Contract Form** - The Contract Form shall not be completed by the tenderer at the time of submitting the tender. The Contract Form shall be completed after contract award and should incorporate the accepted contract price.
5. **Performance Security Form**- The performance security form should not be completed by the tenderers at the time of tender preparation. Only the successful tenderer will be required to provide performance security in the form provided herein or in another form acceptable to the procuring entity.
6. **Bank Guarantee for Advance Payment Form** - When Advance payment is requested for by the successful bidder and agreed by the procuring entity, this form must be completed fully and duly signed by the authorized officials of the bank.
7. **Manufacturers Authorization Form** - When required by the tender documents this form must be completed and submitted with the tender documents. This form will be completed by the manufacturer of the goods where the tenderer is an agent.

8.1 **FORM OF TENDER**

Date _____
Tender No. _____

To: _____

[name and address of procuring entity]

Gentlemen and/or Ladies:

1. Having examined the tender documents including Addenda Nos. *[insert numbers]*.the receipt of which is hereby duly acknowledged, we, the undersigned, offer to supply deliver, install and commission (..... *(insert equipment description)* in conformity with the said tender documents for the sum of *(total tender amount in words and figures)* or such other sums as may be ascertained in accordance with the Schedule of Prices attached herewith and made part of this Tender.

2. We undertake, if our Tender is accepted, to deliver install and commission the equipment in accordance with the delivery schedule specified in the Schedule of Requirements.

3. If our Tender is accepted, we will obtain the guarantee of a bank in a sum of equivalent to _____ percent of the Contract Price for the due performance of the Contract , in the form prescribed by*(Procuring entity)*.

4. We agree to abide by this Tender for a period of *[number]* days from the date fixed for tender opening of the Instructions to tenderers, and it shall remain binding upon us and may be accepted at any time before the expiration of that period.

5. This Tender, together with your written acceptance thereof and your notification of award, shall constitute a Contract, between us. Subject to signing of the Contract by the parties.

6. We understand that you are not bound to accept the lowest or any tender you may receive.

Dated this _____ day of _____ 20 _____

[signature]

[in the capacity of]

Duly authorized to sign tender for an on behalf of _____

8.2 CONFIDENTIAL BUSINESS QUESTIONNAIRE FORM

You are requested to give the particulars indicated in Part 1 and either Part 2(a), 2(b) or 2 (c) whichever applied to your type of business

You are advised that it is a serious offence to give false information on this form

Part 1 – General:

Business Name

.....

Location of business premises.

.....

Plot No..... Street/Road

.....

Postal Address Tel No. Fax E mail ...

Nature of Business

.....

Registration Certificate No.

.....

Maximum value of business which you can handle at any one time – Kshs.

.....

Name of your bankers Branch

Part 2 (a) – Sole Proprietor

Your name in full Age

Nationality Country of origin

• Citizenship details

•

Part 2 (b) Partnership

Given details of partners as follows:

Name	Nationality	Citizenship Details	Shares
1.
2.
3.
4.

Part 2 (c) – Registered Company

Private or Public

State the nominal and issued capital of company-

Nominal Kshs.

Issued Kshs.

Given details of all directors as follows

Name	Nationality	Citizenship Details	Shares
1.
2.
3.
4.
5.

8.3 TENDER SECURITY FORM

Whereas [name of the tenderer]

(hereinafter called “the tenderer”) has submitted its tender dated [date of submission of tender] for the supply, installation and commissioning of [name and/or description of the equipment]

(hereinafter called “the Tender”) KNOW ALL PEOPLE by these presents that WE of having our registered office at (hereinafter called “the Bank”), are bound unto [name of Procuring entity] (hereinafter called “the Procuring entity”) in the sum of for which payment well and truly to be made to the said Procuring entity, the Bank binds itself, its successors, and assigns by these presents. Sealed with the Common Seal of the said Bank this ___ day of _____ 20 _____.

THE CONDITIONS of this obligation are:-

- 1. If the tenderer withdraws its Tender during the period of tender validity specified by the tenderer on the Tender Form; or
2. If the tenderer, having been notified of the acceptance of its Tender by the Procuring entity during the period of tender validity:
(a) fails or refuses to execute the Contract Form, if required; or
(b) fails or refuses to furnish the performance security in accordance with the Instructions to tenderers;

We undertake to pay to the Procuring entity up to the above amount upon receipt of its first written demand, without the Procuring entity having to substantiate its demand, provided that in its demand the Procuring entity will note that the amount claimed by it is due to it, owing to the occurrence of one or both of the two conditions, specifying the occurred condition or conditions.

This tender guarantee will remain in force up to and including thirty (30) days after the period of tender validity, and any demand in respect thereof should reach the Bank not later than the above date.

[signature of the bank]

8.4 CONTRACT FORM

THIS AGREEMENT made the _____ day of _____ 20 _____ between
..... [*name of Procurement entity*] of [*country of Procurement entity*]
(hereinafter called “the Procuring entity) of the one part and [*name of
tenderer*] of [*city and country of tenderer*] (hereinafter called “the tenderer”) of the
other part;

WHEREAS the Procuring entity invited tenders for certain goods] and has accepted a tender by
the tenderer for the supply of those goods in the sum of [*contract
price in words and figures*] (hereinafter called “the Contract Price).

NOW THIS AGREEMENT WITNESSETH AS FOLLOWS:

1. In this Agreement words and expressions shall have the same meanings as are
respectively assigned to them in the Conditions of Contract referred to:

2. The following documents shall be deemed to form and be read and construed as part of
this Agreement viz:

- (a) the Tender Form and the Price Schedule submitted by the tenderer
- (b) the Schedule of Requirements
- (c) the Technical Specifications
- (d) the General Conditions of Contract
- (e) the Special Conditions of contract; and
- (f) the Procuring entity’s Notification of Award

3. In consideration of the payments to be made by the Procuring entity to the tenderer as
hereinafter mentioned, the tender hereby covenants with the Procuring entity to provide the
goods and to remedy defects therein in conformity in all respects with the provisions of the
Contract

4. The Procuring entity hereby covenants to pay the tenderer in consideration of the
provisions of the goods and the remedying of defects therein, the Contract Price or such other
sum as may become payable under the provisions of the Contract at the times and in the manner
prescribed by the contract.

IN WITNESS whereof the parties hereto have caused this Agreement to be executed in
accordance with their respective laws the day and year first above written.

Signed, sealed, delivered by _____ the _____ (for the Procuring entity

Signed, sealed, delivered by _____ the _____ (for the tenderer in the presence of _

8.5 PERFORMANCE SECURITY FORM

To
[name of Procuring entity]

WHEREAS [name of tenderer] (hereinafter called “the tenderer”) has undertaken , in pursuance of Contract No. _____ [reference number of the contract] dated _____ 20 _____ to supply [description of goods] (hereinafter called “the Contract”).

AND WHEREAS it has been stipulated by you in the said Contract that the tenderer shall furnish you with a bank guarantee by a reputable bank for the sum specified therein as security for compliance with the Tenderer’s performance obligations in accordance with the Contract.

AND WHEREAS we have agreed to give the tenderer a guarantee:

THEREFORE WE hereby affirm that we are Guarantors and responsible to you, on behalf of the tenderer, up to a total of [amount of the guarantee in words and figure] and we undertake to pay you, upon your first written demand declaring the tenderer to be in default under the Contract and without cavil or argument, any sum or sums within the limits of [amount of guarantee] as aforesaid, without you needing to prove or to show grounds or reasons for your demand or the sum specified therein.

This guarantee is valid until the _____ day of _____ 20 _____

Signed and seal of the Guarantors

[name of bank]

[address]

[date]

8.6 **BANK GUARANTEE FOR ADVANCE PAYMENT FORM**

To
[*name of Procuring entity*]

[*name of tenderer*]

Gentlemen and/or Ladies:

In accordance with the payment provision included in the Special Conditions of Contract, which amends the General Conditions of Contract to provide for advance payment, [*name and address of tenderer*](hereinafter called “the tenderer”) shall deposit with the Procuring entity a bank guarantee to guarantee its

proper and faithful performance under the said Clause of the Contract in an amount of
..... [*amount of guarantee in figures and words*].

We, the [*bank or financial institutions*], as instructed by the tenderer, agree unconditionally and irrevocably to guarantee as primary obligator and not as surety merely, the payment to the Procuring entity on its first demand without whatsoever right of objection on our part and without its first claim to the tenderer, in the amount not exceeding [*amount of guarantee in figures and words*]

We further agree that no change or addition to or other modification of the terms of the Contract to be performed there-under or of any of the Contract documents which may be made between the Procuring entity and the tenderer, shall in any way release us from any liability under this guarantee, and we hereby waive notice of any such change, addition, or modification.

This guarantee shall remain valid in full effect from the date of the advance payment received by the tenderer under the Contract until [*date*].

Yours truly,

Signature and seal of the Guarantors

[*name of bank*]

[*address*]

[*date*]

8.7 MANUFACTURER'S AUTHORIZATION FORM

To *[name of the Procuring entity]*

WHEREAS*[name of the manufacturer]*
who are established and reputable manufacturers of *[name and/or description of the goods]* having factories at *[address of factory]* do hereby authorize *[name and address of Agent]* to submit a tender, and subsequently negotiate and sign the Contract with you against tender No. *[reference of the Tender]* for the above goods manufactured by us.

We hereby extend our full guarantee and warranty as per the General Conditions of Contract for the goods offered for supply by the above firm against this Invitation for Tenders.

[signature for and on behalf of manufacturer]

Note: This letter of authority should be on the letterhead of the Manufacturer and should be signed by a person competent.

LETTER OF NOTIFICATION OF AWARD

Address of Procuring Entity

To: _____

RE: Tender No. _____

Tender Name _____

This is to notify that the contract/s stated below under the above mentioned tender have been awarded to you.

1. Please acknowledge receipt of this letter of notification signifying your acceptance.
2. The contract/contracts shall be signed by the parties within 30 days of the date of this letter but not earlier than 14 days from the date of the letter.
3. You may contact the officer(s) whose particulars appear below on the subject matter of this letter of notification of award.

(FULL PARTICULARS) _____

**SIGNED FOR
COUNTY SECRETARY**